

4 Sprayer Information

4.1 Solutions for Safer Spraying

Handling and applying pesticides is risky business. Devices known as engineering controls can be used to keep pesticide exposure to a minimum. This section describes how to prevent pesticide exposure at five key areas of potential contamination.

4.1.1 Loading the Sprayer

Closed Transfer Systems allow concentrated pesticide to be moved from the original shipping container to the sprayer mix tank with minimal or no applicator contact. Many systems provide a method to measure the concentrated pesticide. Some systems also include a container rinsing system that pipes rinse water into the spray tank.

Induction Bowls are metal, plastic or fiberglass hoppers attached to the side of the sprayer or nurse tank that allow pesticides to be added to the mix tank without the applicator climbing onto the spray rig. Pesticides are poured into the bowl and water is added to flush out the bowl and carry the pesticide to the spray tank. Often a rinse nozzle is mounted inside the bowl for rinsing out empty pesticide containers. Typically, induction bowls are raised out of the way during spraying and lowered to about 3 feet above ground when loading the sprayer.

Direct Pesticide Injection Systems allow pesticides to be mixed directly with water in the sprayer plumbing system rather than in the main spray tank. The pesticide is pumped from its container and mixed with the water either in a manifold or at the main water pump. Only clean water is held in the main tank of the sprayer. An electronic controller and pumps adjust the amount of concentrated pesticide that is injected into the water stream, allowing for variable application rates.

Container Rinse Systems consist of a rinse nozzle and a catch bowl that traps the container washings (rinsate). The empty container is placed over the rinse nozzle and a jet of water cleans the inside of the container. The rinsate caught in the bowl is pumped into the spray tank to be used along with the spray mixture. Rinse nozzles are often installed in chemical induction bowls.

4.1.2 Contamination at the Boom

Boom Folding/Extending - Manually folding booms can be a major source of operator contamination because the boom can be covered with pesticide from drift or dripping nozzles. Consider the use of hydraulic or mechanical folding methods.

Diaphragm Check Valves - Typically, when a sprayer is shut off and as the system pressure drops, any liquid remaining in the boom piping drips from the nozzles,

possibly dripping onto the boom or even the operator. Diaphragm check valves installed at each nozzle prevent this by using a spring-loaded rubber diaphragm to close off the flow of liquid once the system pressure drops below about 10 pounds per square inch. When the sprayer is switched on and system pressure builds up, the valve opens and allows the liquid to flow through the nozzles.

Multiple Nozzle Bodies - Contamination can occur when operators change or unclog nozzles during an application. Multiple nozzle bodies (or turret nozzles) allow operators to switch between nozzles with a turn of the nozzle body rather than having to unscrew or undo a threaded or a bayonet fitting.

Hand Wash Water Supply - Providing adequate wash water is essential (and often required). A simple container with a hand-operated valve can be mounted on the side of the sprayer to provide clean water for hand washing and personal hygiene.

4.1.3 Sprayer Cab Contamination

Cab Filtration Using Carbon Filters - Carbon filtration systems are used to remove pesticide odor and pesticide-laden mist from fresh air used in a tractor or self-propelled sprayer cab. Carbon filtration systems are often a standard feature on self-propelled sprayers. Many factory installed tractor cabs offer optional filtration systems. Cabs certified under the ASAE standard meet the requirements for enclosed cabs contained in the Worker Protection Standard.

Protective Clothing Lockers - Some sprayer manufacturers offer a simple compartment (orlocker) mounted to the side or front of the sprayer where protective clothing can be stored to prevent contamination of the tractor or sprayer cab interior. Alternatively a locker can be fitted to the nurse tank.

4.1.4 Drift

Low-Drift Nozzles - Low-drift nozzles create larger-size droplets than conventional nozzles. The larger droplet sizes are less prone to drift, reducing environmental and operator contamination.

Air Induction (Twin Fluid) Nozzles - These nozzles allow air to mix with the spray liquid, creating large, air-filled droplets that have virtually no fine, drift-prone droplets. The droplets explode when they contact their target and offer similar coverage to droplets from conventional, finer-spray nozzles.

Use of alternate row spraying with drift controlling nozzles is likely to create poor coverage because the inherent property of these nozzles is to restrict spray deposition within a short distance of the sprayer.

Areas of Potential Pesticide Exposure Risk and Engineering Controls to Reduce Exposure

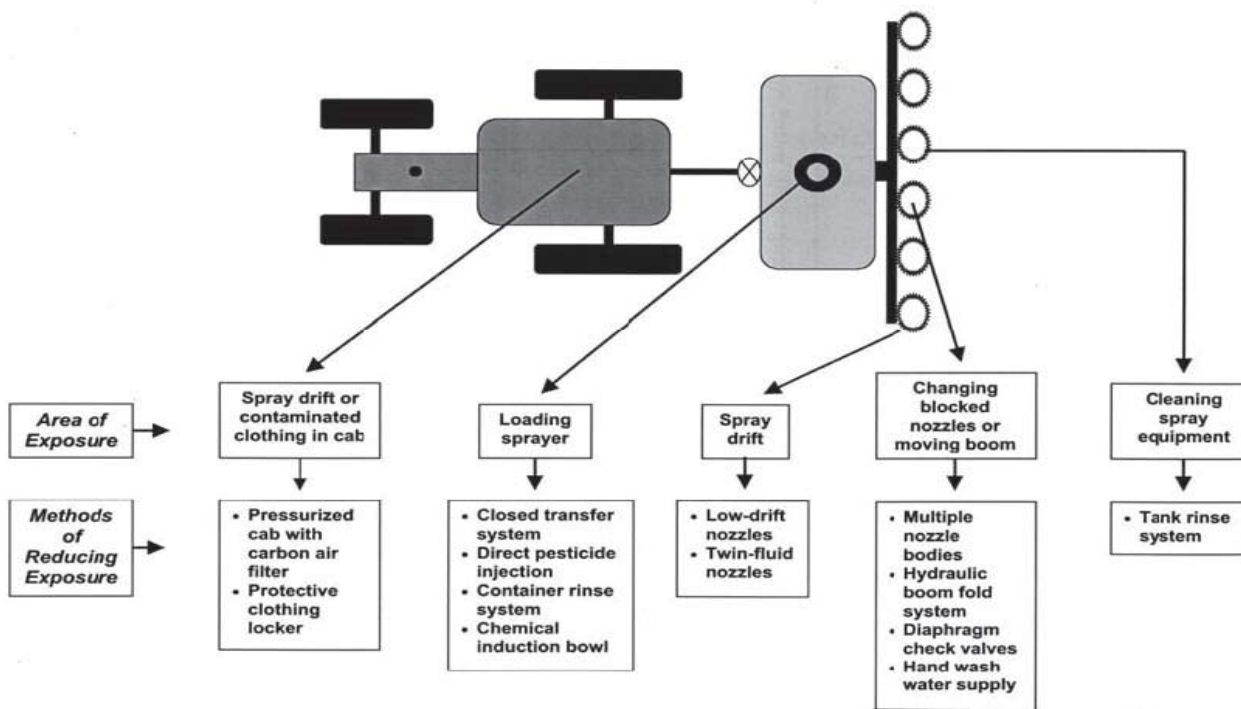

4.1.5 Cleaning the Sprayer

Tank Rinse Systems - Tank rinse systems consist of a clean water supply tank mounted to the sprayer and one or more rotating discs or nozzles mounted inside the main sprayer tank. Water is pumped from the clean water tank to the rinse nozzles, which spray water around the inside of the spray tank. These systems are designed for in-field rinsing of the sprayer so that the tank washings can be applied to the field at label rates.

4.2 Minimizing Pesticide Drift

Spray drift of pesticides is an important and costly problem facing pesticide applicators. Drift results in damage to susceptible off-target crops, environmental contamination to waterways, and a lower than intended rate to the target crop thus reducing efficacy. Drift onto neighboring properties can lead to legal disputes. Applying the correct product to the correct target at the correct time with the correct equipment is the key to good spraying.

There are two types of drift. Vapor drift is usually invisible. The amount of vapor drift depends upon atmospheric conditions such as humidity, temperature and the product being applied, and can occur days after an application is made. The second type, airborne drift, is often very noticeable. The amount of airborne drift is influenced by many interrelated factors including droplet size, nozzle type and size, sprayer design, weather conditions and, last but not least, the operator.

4.2.1 Droplet Size

Switching to lower spray volumes may result in smaller droplet size. Within an effective range, smaller droplets can provide more uniform coverage. There is a lower limit to droplet size because of concerns about drift. Droplets under 150 microns diameter generally pose the greatest hazard. A 100-micron droplet takes 11 seconds approximately to fall ten feet in still air. With a 5 mph wind it will drift about 75-feet before hitting the ground. Droplets less than 50 microns have insufficient momentum for impaction and can remain suspended in the air indefinitely until they evaporate.

The higher the operating pressure, the smaller the droplet; conversely, low pressure produces large droplets that may bounce off the target. Traditional air blast sprayers give the greatest cause for concern as they produce many small droplets, which are often off-target. Certain spray surfactants can change the droplet spectrum, reducing the number of driftable droplets.

4.2.2 Nozzle Type and Size

Modern nozzle technology such as air inclusion nozzles produce larger droplets than conventional cone nozzles. Large droplets normally roll off the leaf, but air inclusion nozzles create air bubbles within the larger droplets, which then collapse on contact with the leaf, dissipating the energy and dispersing the liquid. Research has shown promising results using air inclusion nozzles with air blast sprayers, although further trials are necessary in apple orchards.

Rotary atomizers create smaller, more uniform droplets, which would normally drift. When used in conjunction with a tower and cross-flow fan design, the smaller droplets are directed into the canopy. This type of sprayer, sometimes called controlled droplet application, produces 95–98% of its droplets all of the same size. The size produced depends on the speed of the spinning cage. Advantages include less water, resulting in better timeliness and a more targeted spray. Research shows that controlled droplet application can effectively control orchard diseases and insects.

4.2.3 Sprayer Design

Tower sprayers and tunnel sprayers are better at targeting the spray into the canopy, reducing drift and increasing deposition. The conventional air blast sprayer sends droplets in an air blast from a central fan upwards into the canopy. The tower sprayer, using an air curtain and rotary atomizer has shown excellent results at disease and insect control. Horizontal penetration into the canopy is preferential to vertical penetration from an air blast sprayer. Tunnel sprayers, developed many years ago in Europe and the US, have tremendous advantages in managed orchards using

trellis designs and dwarf trees. The use of a spray collection device at the base of the tunnel canopy results in the ability to recirculate spray with subsequent savings in pesticide and a reduction in drift. Many growers believe that tunnel sprayers are only suitable for level land, but an increasing number are to be found in orchards on undulating land.

Drift problems increase when a space occurs within the row. Air blast sprayers, with or without a tower, can be fitted with ultrasonic or laser canopy sensors. The sensors also detect the shape of a tree and adjust the spray pattern accordingly. The advantages include reduced drift and ground deposition, reduced pesticide use, and more efficient use of spray water allowing and more acres per tankload.

Correct calibration will ensure that all the nozzles are discharging the correct amount of liquid at the correct distance and angle to the target and at the correct forward speed. Operators must set the air deflectors correctly to confine airflow, spray pattern and disturbance to the tree canopy.

German Drift Reduction Methods – Adapted from: Registration of BBA – approved plant protection equipment for orchards in the list of loss reducing equipment.

Key: ID = Lechler Air Induction; AD = Lechler Drift Reducing; TD = Agrotop by GreenLeaf; DG = Drift Guard by TeeJet; AVI = Albuz Air Induction; Website: www.bba.de

Drift Reduction Class	Sprayer	Nozzle Types	Regulations of Use
50%	All air assisted sprayers	ID, TD, AVI, DG, AD Various Sizes	First 5 rows without air towards field edge.
	Foliage Detector	All Types	
	Air assisted sprayers with axial fan.	ID Various Sizes, TD 80-02 Keramik, AVI 80-03	Spray pressure max 58-73 PSI. First 5 rows with reduced air (max 30,000m3/h)
	All air assisted sprayers	All Types	Hail nets above orchards.
75%	All air assisted sprayers	ID, TD, AVI, DG, AD Various Sizes	Hail nets above orchards.
	Sprayers with axial fan with max 30,000 m3/h, at least with first gear.	ID, TD, AVI, Various Sizes	Spray pressure max 58-73 PSI. First 5 rows with reduced air (max 20,000m3/h). AVI 80-015 max 44 PSI, ID 90-015 max 44 PSI
	Tower Sprayer	ID, TD, AVI, DG, AD Various Sizes	First 3 rows spraying without air towards field edge.
	Sprayers with cross flow fan	ID, TD, AVI, DG, AD Various Sizes	First 3 rows spraying without air towards field edge.
90%	Sprayers with cross flow fan.	ID, TD, AVI, DG, AD Various Sizes	First 5 rows spraying with reduced/sealing #4 towards filed edge; sealing #8 inwards.
	Tower sprayers with fan	ID, TD, AVI, DG, AD Various sizes	First 5 rows spraying without air towards field edge. Partly with reduced spray pressure.
	Lipco Tunnel sprayers		
99%	Lipco Tunnel sprayers	ID, TD, AVI, DG, AD Various Sizes	

Herbicide drift from weed control practices is also important. Shielded herbicide sprayers prevent drift from contaminating fruit and damaging leaves and trunks. Shields can vary from the simple to the complex. Shielded sprayers allow growers to apply herbicides in variable weather conditions. Different nozzle types such as hydraulic flat fan nozzles and controlled droplet applicators using reduced herbicide rates.

4.2.4 Weather

Wind speed and direction, relative humidity, temperature and atmospheric stability all affect drift. Research in England and New Zealand has measured the effectiveness of shelterbelts (windbreaks). Shelter belt height and density affect drift, and may, in certain conditions, create additional air currents and eddies. There are so many variables such as topography and wind direction that it is difficult to conclude that research at one site is transferable to another.

4.2.5 Forward Planning

Forward planning is the key to good management. Choose the correct size sprayer with good back-up support to ensure that spraying can be done in a timely manner. Racing around in an attempt to apply pesticides after a problem disease or insect attack has occurred increases chance of errors. The use of orchard field cards to record sprayer settings, pesticide dosage and application rates, quantity required per tank fill, etc. will reduce the chance of errors and stress levels, and will improve efficiency and safety. Use of pest monitoring and forecasts provides warning of needed applications, allowing more preparation time versus discovering problems at the last minute or after they have already occurred.

Before Spraying

1. Train the operator to use the sprayer correctly on your farm under your conditions.
2. Plan the spraying operation; consider the use of orchard field cards as a good management tool.
3. Always read and follow pesticide label instructions.
4. Select the correct nozzle for the target. Adjust the size and position of the nozzles to achieve correct distribution within the canopy, particularly as the growing season progresses.
5. Consider the use of sprayers that direct the spray to the target, such as towers and tunnels. Check that air deflectors are set properly to confine disturbance to the target area.
6. Consider use of spray additives to reduce drift.
7. Improve spraying logistics to ensure adequate time to spray within “ideal” conditions.
8. Only spray when weather conditions are ideal; avoid spraying when conditions are favorable for atmospheric inversion or wind drift. Generally wind speed between 2 and 7 mph is best.
9. Calibrate the sprayer with water to ensure that everything is working correctly.
10. Start planting windbreaks!

During Spraying

1. Stay alert: ensure the spray is not allowed to drift on to non-target areas and watch for changes in wind speed and direction.
2. Use the appropriate pressure for your equipment and nozzles to generate droplet sizes in the 150 – 250 micron range. Regularly check the accuracy of the pressure gauge.
3. Maintain a constant speed and pressure. Small increases in speed can result in large changes in spray penetration, coverage, and amount per acre.
4. Avoid spraying near sensitive crops or waterways; use a 50–100-ft buffer zone. Spray inwards, with one side of the sprayer, for at least 50 feet from the boundary to create a “headland”.

Tools and Options

1. Monitoring equipment. Purchase and use good quality instruments for wind speed, temperature, and humidity.
2. Monitor spray pattern to see where the spray is actually going. One method is to use a patternator. Another method is to use a 16-foot high pole (two 8 foot 2x4 inch boards end to end) with a paper tape stapled along the leading edge. Place the pole between two trees within the row and spray a mixture of clean water and food coloring. Travel between the rows, spraying out the mixture. The spray will stain the paper where it hits. By looking at the colored spray droplets on the paper, you can alter the orientation of the nozzles or deflectors until the spray is only hitting the portion of the vertical pole/trees that is desirable.
3. Air Induction Nozzles (AI): These nozzles, when used properly, can reduce drift by at least 50 percent. These nozzles create a larger droplet that will not drift as far but still maintains good leaf and fruit coverage. Not all AI nozzles are the same.
4. End Plates and One-sided spraying: A shroud can be used to block any air on the opposite side of the sprayer. On the outer rows you can only spray inwards. This can reduce drift by 50 percent.
5. Foliage Sensors: These sensors tell whether or not the sprayer is next to a tree, automatically shutting the spray off if no tree is present. There are ultrasonic or infrared sensor types that if used properly reduce overspray and drift by 50 percent.
6. Hail Nets can reduce drift up to 75 percent.
7. Tower sprayers are better at targeting the spray into the canopy than a conventional air blast. The conventional air blast sprayer sends droplets in an air blast from a central fan upwards into the canopy, whereas the tower sprayer uses a horizontal air curtain.

8. Tunnel Sprayers: Tunnel sprayers are the best way to reduce drift. Very little spray gets out of the tunnel spraying system, allowing for a 90 percent reduction in drift. If AI nozzles are used with the tunnel sprayer, 99 percent of drift can be reduced.
9. Axial fan size and speed: Using an axial fan producing 30,000 cu. meters/hr in conjunction with AI nozzles will result in a 75 percent reduction of drift.
10. PTO speed: Regulating the PTO speed of the tractor is an inexpensive way to reduce drift. Lowering the PTO speed reduces fan speed, preventing excessive amounts of air from blowing pesticides through the target and allowing good deposition to occur. On an airshear type sprayer, reducing PTO speed by 25% reduced drift by 75%. The reduced speed also increased droplet size, further reducing the effects of drift (see NY Fruit Quarterly, Vol. 12 #3, Autumn 2004).
11. Hydraulic Drive: Using a hydraulic motor to drive the sprayer fan will allow you to regulate airspeed velocity separately from tractor speed.
12. Cornell Doughnuts: These attachments restrict air intake to reduce air flow through the sprayer. For early season, the 1/2 air intake doughnut can be used to only allow enough air to penetrate just the target row. A 2/3rd air intake hole can be used for early/mid-season to allow more air. Finally, in full canopy, no doughnut is required.
13. Drift-reducing additives usually work by increasing droplet size. Beware, not all of them can withstand the higher pressures associated with fruit sprayers and need independent verification.
14. Calibrate and check that the sprayer is functioning correctly.

Conclusion

Drift is impossible to eliminate but can be minimized. Implementing just one of these methods will greatly reduce the effects of drift and improve your efficiency of spray application, saving you time, money, and future problems.

4.3 Preparing an Air Blast Sprayer

4.3.1 Checking the Sprayer

Sprayers must be regularly checked over to ensure that proper maintenance has been carried out and that no outstanding repairs need to be done. Faulty sprayers contribute to increased drift levels and waste money through inefficiency and overuse of chemicals.

Before attempting any work on a machine make sure that it is fully supported on stands and that all necessary protective clothing is on hand.

Maintenance measures such as fitting a new set of nozzles at the beginning of each season also save money. Even when there is overdosing by as little as 5%, the cost of a

new set of nozzles will be recovered in less than one of spraying.

Caution –

- Take great care when adjusting a sprayer while the tractor engine is running.
- Always ensure that the fan is stationary before approaching the rear of the sprayer.
- Engage the handbrake when leaving tractor seat.

4.3.2 Fitting the Sprayer to the Tractor

The selected tractor must always be powerful enough to operate the sprayer efficiently under the working conditions that will be encountered. All its external services – hydraulic, electrical and pneumatic – must be clean and in working order. Tractors fitted with cabs must have efficient air filtration systems. All protective guards must be in place. Trailed sprayers are often close-coupled to the tractor, so it is essential that the drawbar and the PTO shaft are correctly adjusted for turning. PTO shafts must be disengaged when making very tight turns.

4.3.3 Checking the Operation of the Sprayer

Part fill the tank with clean water and move the sprayer to uncropped waste ground. Remove the nozzles. Although not using any chemical at this point, get into the habit of wearing a coverall, gloves and a face visor when working with the sprayer. Engage the PTO and gently turn the shaft, increasing speed slowly to operating revs. Test the on/off and pressure relief valves, and check the agitation system. Flush through the spray lines, then switch off the tractor. Refit the nozzles and check the liquid system again for leaks.

4.3.4 Pre-Season Maintenance Checklists

Hoses

- for splits and cracks
- connections to ensure they are water-tight
- for hose chafe, particularly in routing clips

Filters

- for missing filter elements and seals
- for leakage
- for blocked or damaged filters

Tank

- for fractures and any other damage
- the tank sits firmly in its mount
- the securing straps are correctly adjusted
- the agitation is working
- the tank is clean

Controls

- the control circuitry (electrical, hydraulic or air) for correct operation
- valves for both internal and external leaks

Pump

- lubrication levels
- for leaks
- the air pressure in the pulsation chamber (if fitted) is at the recommended level
- the pump rotates freely without friction or noise. Do so by rotating manually or starting at low speed (corrosion may cause seizing up)

Pressure Gauge

The pressure gauge is vital for indicating whether the nozzles are delivering the correct amount of chemical per unit time while spraying. If you have any doubts about the pressure gauge, replace it or refer the problem to the manufacturer or supplier. **The cost of replacing a faulty pressure gauge which has been indicating at 15% below the actual pressure is recouped in around two hours operation.**

Nozzles

- the correct nozzles are at each location
- all nozzles are in good condition, with no leaks around the body
- all nozzles are clean and free from obstruction (note: clean with a soft brush or airline – don't damage nozzles by using wires or pins)
- all nozzles deliver to within + or - 5% of the manufacturer's chart value

Using water only, run the sprayer at the specified pressure and collect the output from each nozzle in turn for a period of 60 seconds. Record each output and replace those outside the 5% tolerance stated in the manufacturer's chart.

Controllers

Where your sprayer has automatic controllers to monitor the speed of the sprayer and the flow, pressure and area sprayed, check that:

- they are in good condition and properly maintained.
- they are frequently calibrated for accuracy, leaks, blockages, variations in pressure or any minor damage during spraying.

Routine Maintenance

The following checks should be carried out routinely:

- All hoses are tightly connected and free from sharp bends; cracked or damaged hoses must be replaced.
- All controls move freely and are fully adjustable.
- Pressure gauge reads zero.
- Pump can be turned over by hand.
- Fan turns freely and is not obstructed; bearings are sound and lubricated.
- Air pressure in pump accumulator (if fitted) is correctly adjusted.
- Drain plugs and clean filters are in position.
- Tires on trailed machines are sound and correctly inflated; wheel nuts are tight.

4.4 Sprayer Calibration

Accurate calibration of orchard spray equipment is essential for efficient and effective use of pesticides and other spray materials. Calibration starts with having a sprayer with adequate capacity to distribute the spray evenly throughout the trees. Sprayer performance is limited by pump output, maximum pressure, fan capacity, and travel speed. The best spray coverage and deposit are obtained within the manufacturer's recommended operating range.

4.4.1 Travel Speed

Travel speed is a critical factor in maintaining accurate application rates and will influence spray deposition within the canopy. The higher the travel speed, the greater the variability in spray deposit. Speed over 4 mph greatly increases risk of poor coverage.

Factors that will affect travel speed include:

- Weight of sprayer being pulled
- Slope of terrain
- Ground conditions and traction (wheel slippage!)

The best way to measure travel speed is to pull a sprayer with tank half filled with water on the same type of terrain that the sprayer will be operated on. Set up test course at least 100 feet long, measure the course with a tape measure. Do not pace the distance. The longer the course the smaller the margin of error. Run the course in both directions.

Use an accurate stop watch to check the time required to travel the course in each direction. Average the two runs and use the following formula to calculate the speed in MPH.

$$\text{Formula: } \text{MPH} = \frac{\text{feet traveled}}{\text{seconds}} \times \frac{60}{88}$$

Your numbers:

Tractor gear _____ Engine RPM _____

$$\text{MPH} = \frac{\text{feet traveled}}{\text{seconds}} \times \frac{60}{88}$$

NOTE: You can also use a hand-held GPS receiver to measure forward speed.

4.4.2 Dilute Gallons per Acre

For trees on standard rootstock and row spacing, a dilute application to the point where additional spray would just run-off the leaves requires about 400 gallons water per acre (GPA). Trees in modern orchards on semi-dwarf or dwarf rootstocks require much less water per acre for a dilute application.

The amount of dilute spray required to adequately cover trees also varies with growth stage and canopy density. Unless adjustments are made in the spray delivery, spray

pattern, and fan output required by differences in tree size and canopy density, difficulties such as inadequate pest control or excessive application of material will result.

Use the **Tree Row Volume (TRV)** formula to calculate the canopy volume and dilute gallons per acre for your blocks.

Canopy width is the average width of the trees looking along the row.

Row length per acre is 43,560 square feet per acre divided by the distance between rows.

Step 1: Canopy Volume per Acre

TRV = Canopy width x Tree height x Row length per acre

$$\begin{array}{r} \text{Tree row} \\ \text{volume} \\ \text{(cu ft/acre)} \end{array} = \begin{array}{r} \text{Canopy} \\ \text{width} \\ \text{(feet)} \end{array} \times \begin{array}{r} \text{Tree} \\ \text{height} \\ \text{(feet)} \end{array} \times \frac{43,560 \text{ sq. ft./acre}}{\text{Distance between rows (feet)}}$$

Example 1a:

Trees are 12 feet wide and 11 feet tall in rows 20 feet apart

$$\begin{aligned} &= 12 \text{ ft.} \times 11 \text{ ft.} \times \frac{43,560 \text{ sq. ft./acre}}{20} \\ &= \frac{132}{0} \times 2178 = 287,496 \text{ cu. ft./acre} \end{aligned}$$

Step 2: Dilute Gallons per Acre

It takes about 0.5 gallon to cover 1,000 cubic feet of tree canopy volume early in the spring, about 0.7 gallon at Petal Fall, and about 1.0 gallon in late summer. If you want to use a single value for the whole season, assume 0.7 gallon per 1,000 cu. ft. of canopy volume for reasonably well pruned trees. For large poorly pruned trees, 1.0 gallon per 1,000 cu. ft. is a safer estimate to insure good coverage.

Example 1b: Dilute gallons per acre for pruned orchard.

$$\begin{array}{r} \text{Dilute gallons} \\ \text{per acre} \\ \text{(DGA)} \end{array} = \begin{array}{r} \text{Tree row} \\ \text{volume} \\ \text{(cu. ft./acre)} \end{array} \times \frac{0.7 \text{ gal}}{1,000 \text{ cu. ft.}}$$

$$\text{DGA} = 287,496 \text{ cu. ft.} \times \frac{0.7 \text{ gal}}{1,000 \text{ cu. ft.}} = 201 \text{ gallons}$$

Example 1c: Dilute gallons per acre for thick canopies (either poorly pruned or near end of summer at maximum foliage density)

$$\begin{array}{r} \text{Dilute} \\ \text{gallons per} \\ \text{acre (DGA)} \end{array} = \begin{array}{r} \text{Tree row} \\ \text{volume} \\ \text{(cu. ft./acre)} \end{array} \times \frac{1.0 \text{ gal}}{1,000 \text{ cu. ft.}}$$

$$\text{DGA} = 287,496 \text{ cu. ft.} \times \frac{1.0 \text{ gal}}{1,000 \text{ cu. ft.}} = 287 \text{ gallons}$$

For very small trees, the TRV formula yields dilute gallons per acre estimates of less than 100 gallons per acre. Spray trials on the efficacy of adjusting spray volume and pesticide dosage according to TRV calculation are inconclusive, but suggest that below a certain minimum gallons per acre, the inefficiency of spray capture by very small trees prevents further reduction in spray volume.

The exact value for this basement level is unclear, but is somewhere between 100 and 200 gallons per acre. For example, assuming a 200 gallon per acre minimum means that even if the TRV calculation generates a lower value, you would estimate spray concentration and pesticide dosage on the assumption that the block need 200 gallons per acre for a dilute application.

To check the accuracy of your calculations, a rough estimate of dilute gallons per acre can be made by using Table 4.4.1.

Table 4.4.1 Dilute gallons per acre for mature trees of different sizes and row spacings.

Distance Between Rows (feet)	Canopy Width (feet)	Tree Height (feet)	Dilute Gallons per Acre
40	28	20	427
40	28	16	342
30	20	15	305
25	16	14	273
22	14	13	252
20	12	12	220
18	10	12	203
16	8	10	152
14	6	10	131
12	5	10	127
11	4	10	111
10	3	9	82

4.4.3 Concentrate Sprays

Concentrate spraying is reducing the gallons of water sprayed per acre below the dilute rate. This can reduce or eliminate run-off, and increases the speed and efficiency of spraying by getting more acres covered per tankload and reduce the number of tank refills needed.

However, as the gallons of water per acre used to apply spray materials is reduced, errors become more critical and risk of poor coverage increases. The upper limit on acceptable spray concentration depends on several factors including: the pest being controlled, canopy density, weather conditions, and the types materials being applied. Sprays at 1X (dilute) to 3X concentration are generally more effective and are preferred for applying growth regulators, chemical thinners, drop inhibitors, nutrient sprays. Miticides, and insecticides for control of pests such as scales and woolly aphid are also generally more effective at higher spray volumes as are bactericide, and fungicides applied for postinfection activity against apple scab.

For most other insecticide and fungicide applications, concentrate sprays in the range of 6X to 8X usually provide satisfactory results. Above 8X, the additional savings in refill time, speed and cost of application are minimal, and frequency of poor spray performance increases.

$$\text{Concentration} = \frac{\text{Dilute gallons per acre}}{\text{Actual gallons per acre sprayed}}$$

Example 1: If the dilute gallons per acre is 200 and the sprayer is applying at 66 gallons/acre, then the concentration is:

$$\frac{200 \text{ gals. water/acre}}{66 \text{ gals. water/acre}} = 3X$$

Example 2: If the dilute gallons per acre is 200 and the sprayer is applying at 50 gallons/acre, then the concentration is:

$$\frac{200 \text{ gals. water/acre}}{50 \text{ gals. water/acre}} = 4X$$

Concentrate spray tank mixing:

If a spray material has a dilute label rate of 1 lb. per 100 gallons dilute, then for an application made at 3X, you need to add 3 lbs. of product for each 100 gallons of tank mix. For a 4X spray, you would add 4 lbs. to each 100 gallons of tankmix.

For pesticide labels that give only a rate per acre, the standard assumption is that “acre” refers to an orchard of standard trees that require 400 gallons per acre for a dilute application. In which case the amount per 100 gallons dilute would be 1/4th the label rate per acre. However, not all labels follow this convention. Also, some labels call for a minimum amount of product per acre regardless of how small the trees are.

4.4.4 Sprayer Output (Gallons per Minute)

In order to choose nozzles with the correct delivery rate, you first need to calculate the total gallons per minute needed from all of the nozzles on the sprayer. This depends on the gallons per acre of actual spray delivery, travel speed, and row width. There are several ways to adjust output and spray pattern when spraying multiple blocks with different gallons per acre and spray patterns. You can set up the sprayer for the largest trees and use flip nozzles to adjust for smaller trees or turn off nozzles not needed for smaller trees. Adjusting travel speed within the range of 2 – 4 mph is another way to adjust spray volume per acre.

Adjusting pressure is NOT a good way to adjust spray delivery. Pressure must change by the square of the desired change in delivery rate. For example, to increase the flow rate by 40%, the pressure must be doubled (1.4 x 1.4 = 2). Sprayers and nozzles are designed to operate within a relatively narrow pressure range, and so cannot operate properly with large changes in pressure.

$$\text{Gallons/minute (GPM)} = \frac{\text{GPA} \times \text{mph} \times \text{Row width}}{495}$$

GPM = total sprayer output in gallons/minute
mph = travel speed in miles per hour
Row width = width between rows of trees in feet
495 = a mathematical constant to correct units of measurement

Example: The orchard requires 200 gallons per acre for a dilute spray, and will be sprayed at 3X. So the sprayer must deliver 66 gallons per acre. The sprayer has 6 nozzles on each side. The comfortable forward speed for our ground conditions is 3mph. Rows are 20 feet apart.

$$\text{GPM} = \frac{66 \text{ GPA} \times 3\text{mph} \times 20 \text{ feet row width}}{495} = 8$$

8 GPM for two sides = 4 gallons per minute per side

4 gallons divided by 6 nozzles = 0.67 GPM per nozzle.

You could use a combination of different nozzles as long as the total output for all nozzles on a side = 4 gallons per minute at the chosen operating pressure.

To check accuracy of gallons per minute calculations, you can divide the desired gallons per acre by a rough estimate of the minutes travel time per acre from Table 4.4.2.

Table 4.4.2. Approximate time required to spray 1 acre of orchard (two-sided sprayer operation, spraying both sides of trees).

Distance between Rows (feet)	Linear feet of Row/acre ¹	Travel speed (mph)				
		1	1.5	2	2.5	3
<i>minutes per acre²</i>						
40	1089	12.4	8.2	6.2	5.0	4.1
30	1452	16.5	11.0	8.2	6.6	5.5
25	1742	19.8	12.4	9.9	7.9	6.6
22	1980	22.5	15.0	11.2	9.0	7.5
20	2178	24.8	16.5	12.4	9.9	8.3
18	2420	27.5	18.3	13.8	11.0	9.2
16	2723	30.9	20.6	15.5	12.4	10.3
14	3112	35.4	23.6	17.7	14.1	11.8

4.5 Nozzle Information

The following websites have information on nozzles and other orchard spraying equipment:

www.albuz.com.fr/

Agricultural and industrial nozzles.

www.delavanagspray.com/Index.htm

Nozzles, nozzle accessories, sprayer accessories, high pressure guns/nozzles, pumps and high pressure washers, calibration, and a nozzle selection guide.

www.hardi-us.com/html/home.html

Sprayers for all crops, nozzles, pumps and electronic controllers, sprayer servicing, and a nozzle selection guide.

www.hypropumps.com/Agriculture/default.cfm

Pumps, boom and sprayer components, nozzle bodies, pressure washer pumps, spray tips, and nozzle selection. They are the US distributor for Albuz nozzles.

www.lechlerusa.com/whois.asp

Nozzles and sprayer components, nozzle selection and sprayer conversion.

www.teejet.com/ms/teejet/

Nozzles, spray guns, valves, manifolds, boom components, electronic controls guidance systems. Site also has a spray calibration calculator and a nozzle selection guide you can download.

www.turbodrop.com/index.html

Nozzles for turf, vegetables and other crops. The featured products are the Turbodrop, Spraymax and Airmix nozzles. Has a nozzle guide plus information on droplet size and independent test data.

www.wilger.net/home.html

Various sprayer parts and nozzles. Some of their featured products include tips, caps, strainers, nozzle bodies and flow indicators. Nozzle selection and detailed information about each nozzle.

www.nysaes.cornell.edu/ent/faculty/landers/pestapp/

Cover multiple types of sprayers (air-blast, boom and knapsack). Hasw links to most of the manufacturers of orchard, vineyard, turf, and vegetable spraying equipment. includes sprayer calibration, nozzles, and publications on sprayer research projects conducted in the Northeast.

4.6 Selecting Airblast Sprayer Nozzles

Example: Using a hollow cone nozzle lookup table from a Spraying Systems catalogue shown on the next page to select a disc and whirlplate combination.

1. Read along the pressure row at the top of the table.

2. Read down the column for 80 psi until you find a value close to the target 0.67 gpm, finding 0.64 gpm. Then looking to the left you will see we need a D5 disc with a DC45 whirl plate or core.
3. Alternatively, you may read down the column for 100 psi until you find 0.70 gpm. Look across to the left and you will see we need a D6 disc with a DC25 whirl plate or core.

A better alternative to consider is a one-piece hollow cone nozzle tip. These are easier to fit into the cap and are much easier to remove for cleaning, changing tips etc.

Example:

To find a nozzle tip with a flow rate near 0.67 gpm for a sprayer operating at 200 psi, using the Conejet hollow cone nozzle table from Spraying Systems TeeJet catalogue:

1. Read along the pressure row at the top of the table.
2. Read down the column for 200 psi until you read 0.667 gpm, look across to the left, you will see we need a blue TXVK-18 one-piece nozzle.

4.7 Calibrating Airblast Sprayers

A simple vertical patternator can be constructed in the farm workshop using readily available materials; a build list and photographs can be found at: <www.nysaes.cornell.edu/ent/faculty/landers/pdf/Patternator.pdf>

Videos showing calibration and nozzle selection may be found at: www.youtube.com. Search for "Calibration of airblast sprayers for orchards part 1 selecting and changing nozzles" or "Calibration of airblast sprayers for orchards part 2 measuring liquid flow".

It is a valuable exercise to assess the spray deposits at various points in the canopy and on upper and lower leaf surfaces of the trees to be sprayed. This is particularly important if the foliage is dense or if the trees are grown in beds of three or more rows. Water-sensitive papers, food coloring, fluorescent tracers, or Surround kaolin clay are available for this purpose. An increase in spray volume or adjustment of the nozzles and their locations may be necessary in order to achieve the correct deposits.

Check Nozzle Pressure (Use clean water!)

Place a pressure gauge on the nozzle fitting farthest away from the pump and turn the sprayer on. If pressure is lower at the nozzle than specified, increase pressure at the regulator.



Pressure at nozzle _____psi

Pressure at sprayer gauge _____psi

Test Nozzle Output

Use a flow meter (obtainable from Gemplers, Spraying Systems, etc.) attached to individual nozzles, OR

Connect hoses to each of the nozzles and measure the flow from each nozzle into a calibrated jug for one minute.

			GPM												
			10 PSI	20 PSI	30 PSI	40 PSI	60 PSI	80 PSI	100 PSI	150 PSI	200 PSI	300 PSI	20 PSI	40 PSI	80 PSI
D1	DC13	.031"	—	—	.059	.066	.078	.088	.097	.115	.128	.152	—	51°	62°
D1.5	DC13	.036"	—	.057	.067	.075	.088	.098	.110	.127	.142	.167	38°	55°	66°
D2	DC13	.041"	—	.064	.075	.08	.10	.11	.12	.14	.16	.18	49°	67°	72°
D3	DC13	.047"	—	.071	.08	.09	.11	.12	.13	.16	.18	.20	53°	70°	75°
D4	DC13	.063"	.070	.09	.11	.12	.14	.16	.17	.20	.23	.27	69°	79°	83°
D1	DC23	.031"	—	—	.064	.072	.080	.096	.107	.124	.139	.164	—	47°	58°
D1.5	DC23	.036"	—	.064	.076	.086	.103	.117	.130	.155	.175	.210	34°	51°	62°
D2	DC23	.041"	—	.078	.092	.10	.13	.14	.16	.19	.21	.25	51°	63°	70°
D3	DC23	.047"	.065	.087	.10	.12	.14	.16	.18	.21	.24	.28	58°	69°	75°
D4	DC23	.063"	.082	.113	.14	.15	.19	.21	.23	.28	.32	.38	68°	82°	87°
D5	DC23	.078"	.095	.13	.16	.18	.22	.25	.28	.34	.38	.46	79°	89°	94°
D6	DC23	.094"	.112	.15	.19	.21	.26	.29	.32	.39	.45	.54	84°	93°	98°
D1	DC25	.031"	—	—	.088	.101	.122	.138	.156	.185	.210	.255	—	27°	43°
D1.5	DC25	.036"	—	—	.118	.135	.162	.185	.205	.245	.280	.33	—	38°	49°
D2	DC25	.041"	—	.12	.14	.16	.19	.22	.25	.29	.34	.41	39°	51°	58°
D3	DC25	.047"	.10	.14	.17	.19	.23	.26	.29	.35	.40	.48	52°	61°	67°
D4	DC25	.063"	.15	.21	.25	.29	.35	.40	.45	.54	.62	.75	67°	74°	80°
D5	DC25	.078"	.18	.25	.30	.35	.42	.48	.54	.65	.75	.90	73°	79°	84°
D6	DC25	.094"	.23	.32	.39	.44	.54	.70	.81	.97	1.19	1.37	79°	85°	89°
D7	DC25	.109"	.26	.37	.45	.52	.63	.73	.81	.98	1.18	1.37	85°	91°	93°
D8	DC25	.125"	.31	.43	.53	.61	.75	.89	.97	1.19	1.36	1.68	91°	96°	97°
D10	DC25	.156"	.38	.54	.65	.76	.93	1.07	1.21	1.48	1.71	2.1	97°	102°	103°
D12	DC25	.188"	.46	.61	.80	.93	1.15	1.32	1.47	1.81	2.09	2.55	103°	109°	112°
D14	DC25	.219"	.51	.72	.88	1.03	1.26	1.47	1.65	2.02	2.34	2.89	108°	113°	114°
D1	DC45	.031"	—	—	—	.125	.148	.170	.190	.225	.257	.310	—	22°	34°
D1.5	DC45	.036"	—	—	.14	.16	.20	.23	.25	.31	.35	.43	—	33°	44°
D2	DC45	.041"	—	.14	.18	.20	.25	.28	.32	.38	.44	.53	32°	46°	55°
D3	DC45	.047"	—	.17	.20	.23	.28	.33	.36	.44	.51	.62	40°	53°	60°
D4	DC45	.063"	.18	.25	.31	.36	.43	.50	.56	.68	.78	.95	62°	69°	72°
D5	DC45	.078"	.23	.32	.39	.45	.54	.64	.71	.86	.99	1.22	67°	73°	76°
D6	DC45	.094"	.29	.41	.50	.58	.72	.83	.93	1.15	1.33	1.64	73°	79°	81°
D7	DC45	.109"	.33	.48	.59	.68	.84	.97	1.11	1.35	1.57	1.94	81°	86°	87°
D8	DC45	.125"	.41	.59	.72	.84	1.04	1.21	1.35	1.68	1.94	2.40	86°	90°	90°
D10	DC45	.156"	.54	.77	.94	1.10	1.35	1.57	1.77	2.18	2.50	3.10	90°	93°	93°
D12	DC45	.188"	.67	.95	1.17	1.36	1.68	1.95	2.20	2.69	3.11	3.80	97°	100°	102°
D14	DC45	.218"	.75	1.07	1.32	1.53	1.89	2.19	2.45	3.00	3.49	4.30	101°	104°	105°
D16	DC45	.250"	.86	1.25	1.54	1.79	2.20	2.57	2.89	3.54	4.11	5.20	108°	111°	112°
D1	DC46	.031"	—	—	—	.145	.178	.205	.23	.28	.32	.39	—	13°	15°
D1.5	DC46	.036"	—	—	—	.213	.260	.300	.33	.41	.46	.56	—	15°	17°
D2	DC46	.041"	—	—	.24	.27	.33	.37	.42	.50	.57	.68	—	18°	21°
D3	DC46	.047"	—	.23	.28	.32	.39	.45	.51	.61	.70	.86	14°	20°	24°
D4	DC46	.063"	.28	.39	.48	.56	.68	.78	.88	1.07	1.23	1.52	23°	29°	33°
D5	DC46	.078"	.38	.54	.66	.77	.94	1.10	1.25	1.50	1.73	2.13	33°	39°	42°
D6	DC46	.094"	.55	.78	.95	1.10	1.35	1.58	1.73	2.16	2.50	3.06	42°	48°	50°
D7	DC46	.109"	—	.98	1.22	1.39	1.72	1.97	2.22	2.73	3.15	3.85	48°	53°	56°
D8	DC46	.125"	—	—	1.59	1.84	2.25	2.62	2.93	3.60	4.17	5.05	—	60°	62°
D10	DC46	.156"	—	—	2.15	2.48	3.05	3.53	3.96	4.83	5.59	6.80	—	66°	68°

Nozzle	PSI	GPM																	
		30	40	50	60	70	80	90	100	120	140	160	180	200	220	240	260	280	300
TXVK-1	100	0.015	0.017	0.018	0.020	0.021	0.022	0.023	0.024	0.026	0.028	0.030	0.031	0.032	0.034	0.035	0.036	0.037	0.038
TXVK-2	100	0.029	0.033	0.037	0.040	0.043	0.045	0.047	0.050	0.054	0.058	0.061	0.064	0.067	0.070	0.073	0.075	0.078	0.080
TXVK-3	100	0.044	0.050	0.055	0.060	0.064	0.068	0.071	0.075	0.081	0.086	0.092	0.096	0.101	0.105	0.109	0.113	0.117	0.120
TXVK-4	50	0.058	0.067	0.074	0.080	0.086	0.091	0.096	0.101	0.110	0.118	0.125	0.132	0.139	0.145	0.151	0.157	0.162	0.167
TXVK-6	50	0.088	0.100	0.111	0.120	0.129	0.137	0.145	0.152	0.165	0.177	0.188	0.199	0.208	0.218	0.226	0.235	0.243	0.251
TXVK-8	50	0.116	0.133	0.148	0.162	0.174	0.186	0.196	0.207	0.225	0.243	0.259	0.274	0.288	0.301	0.314	0.326	0.338	0.349
TXVK-10	50	0.145	0.167	0.185	0.202	0.218	0.232	0.246	0.258	0.282	0.303	0.323	0.342	0.360	0.376	0.392	0.408	0.422	0.437
TXVK-12	50	0.174	0.200	0.223	0.243	0.261	0.279	0.295	0.310	0.338	0.364	0.388	0.410	0.432	0.452	0.471	0.489	0.507	0.524
TXVK-18	50	0.260	0.300	0.335	0.367	0.396	0.423	0.449	0.473	0.517	0.558	0.597	0.633	0.667	0.699	0.730	0.759	0.788	0.815
TXVK-26	50	0.376	0.433	0.484	0.530	0.572	0.611	0.648	0.683	0.747	0.807	0.862	0.914	0.963	1.01	1.05	1.10	1.14	1.18
TX†800050VK	100	0.044	0.050	0.055	0.060	0.064	0.068	0.071	0.075	0.081	0.086	0.092	0.096	0.101	0.105	0.109	0.113	0.117	0.120
TX†800067VK	50	0.058	0.067	0.074	0.080	0.086	0.091	0.096	0.101	0.110	0.118	0.125	0.132	0.139	0.145	0.151	0.157	0.162	0.167
TX†8001VK	50	0.088	0.100	0.111	0.120	0.129	0.137	0.145	0.152	0.165	0.177	0.188	0.199	0.208	0.218	0.226	0.235	0.243	0.251
TX†80015VK	50	0.131	0.150	0.167	0.182	0.196	0.209	0.221	0.232	0.254	0.273	0.291	0.308	0.324	0.339	0.353	0.367	0.380	0.393
TX†8002VK	50	0.174	0.200	0.223	0.243	0.261	0.279	0.295	0.310	0.338	0.364	0.388	0.410	0.432	0.452	0.471	0.489	0.507	0.524
TX†8003VK	50	0.260	0.300	0.335	0.367	0.396	0.423	0.449	0.473	0.517	0.558	0.597	0.633	0.667	0.699	0.730	0.759	0.788	0.815
TX†8004VK	50	0.347	0.400	0.447	0.489	0.528	0.564	0.598	0.630	0.690	0.745	0.796	0.843	0.889	0.932	0.973	1.01	1.05	1.09

Remember 128 fl. oz. = one gallon.

Example: If the output of one nozzle has been measured at 83 fl. oz. in one minute, then output per minute is divided by 128 = 0.65 GPM.

Record the output of each nozzle and compare the actual to the desired output. Examine and replace if necessary all nozzle tips that are more than 5% inaccurate. In this example, with a desired nozzle output of 0.67 GPM, then a nozzle delivering less than 0.63 GPM, or more than 0.70 GPM, at the operating pressure should be examined and if necessary, replaced.

4.7.1 Calibrating a Kinkelder Tree Sprayer

Formula:

$$\frac{\text{Rate of spray gals/acre} \times \text{Forward speed mph} \times \text{Row spacing ft} \times 60}{500} = \text{gals/hr delivery}$$

Your numbers:

$$\frac{\text{gallons/acre} \times \text{mph} \times \text{ft} \times 60}{500} = \text{gals/hr delivery}$$

This figure should be set on both scales.

Both taps should be set on the distribution conduit in such a way that the index is set on the sign 162 on the index plate of the distribution conduit. The emission indication on the index plate has been fixed at a working pressure of 21 lbs (1.5 bar).

Check the output of the sprayer (Use clean water!):

1. Divide the gallons/hour figure obtained above by 60 to give output/minute e.g., 162 gpm divided by 60 = 2.7

2. Remove the plastic pipes from the nozzles on the left or right side, tie together and place in a measuring jug
3. Run the sprayer for one minute at correct engine speed, collecting the output in a measuring jug.

Remember 128 fl. Ozs = one gallon.

Example: If the output of one side has been measured at 173 fl. ozs, then output is divided by 128 = 1.35 gallons per minute.

4. Then check the output of the opposite side.

4.7.2 Calibrating an Agtec Tree Sprayer

1. **Formula:**

$$\frac{\text{Speed} \times \text{gallons/acre} \times \text{Row width}}{1000} = \text{Gallons per minute/side}$$

Your numbers:

$$\frac{\text{mph} \times \text{gallons/acre} \times \text{ft}}{1000} = \text{Gallons per minute/side}$$

2. Check AgTec tables for correct meter setting, select the gal/min as calculated above, and then find the meter setting, e.g., meter #12 @30 psi gives 1.34 gallons/min.
3. Remove the hoses from the nozzles on the left or right side, tie together and place in a measuring jug
4. Run the sprayer for one minute at correct engine speed, collecting the output in a measuring jug. Remember 128 fl. ozs = one gallon.

Example: Output of one side at 173 fl. ozs. divided by 128 = 1.35 gallons per minute.

5. Then check the output of the other side.

4.8 Orchard Weed Control Equipment

Herbicides, although relatively inexpensive, require good application techniques to improve deposition and drift reduction. Off-target drift wastes money, reduces deposition on the target plant, damages trees, pollutes water courses, and may cause health effects in humans.

4.8.1 Boom Applicators

A boom may be fitted either to the front of the tractor or be mid-mounted for spraying one side of the adjacent row. Typical spray volume is 20–30 gallons per acre.

The use of hoods and break-back devices are important. A hood will protect the branches from drift created by the small droplets being emitted from the conventional flat fan nozzle. A break-back device will protect the sprayer boom and nozzle from damage caused by inadvertently striking a trunk or trellis post etc. Break-back devices normally comprise a spring-loaded arm.

Boom manufacturers/distributors include: Phil Brown Welding Corp., The Green Hoe Co. Inc., OESCO, Inc.

Correct Nozzle Selection

Correct nozzle selection is one of the most important yet inexpensive aspects of pesticide application. A nozzle's droplet size spectrum determines deposition and drift and is referred to as spray quality. Modern nozzle catalogues provide information on spray quality for each nozzle, when applying herbicides, we need to select a MEDIUM quality spray. Conventional flat fan nozzles produce droplets in the range of 10–450 microns. There are 25,000 microns in one inch. Drift is a major problem with droplets less than 150 microns.

Increasing the Volume Median Diameter (VMD) will certainly reduce drift, but too large a droplet (>300 microns) will bounce off the leaves to the ground, thus causing pollution, wasting money and resulting in less product on the target.

Conventional Flat Fan Nozzles

Nozzles with 80 degree angle produce coarser droplets than 110 degree angles at the same flow rate, but 80 degree nozzles require the boom to be set at 17–19 inches, whereas 110 degree nozzles can be set lower at 15–18 inches above the target. (The lower the boom, the less chance of drift). Spray quality is fine – medium at 15–60 psi.

Pre-orifice Flat Fan Nozzles

The internal design of this nozzle reduces the internal operating pressure compared with a conventional flat fan, resulting in coarser droplets (high pressure creates fine droplets, low pressure creates coarser droplets). Available as 800 or 1100 nozzles. Spray quality is medium–coarse at 30–60 psi. Drift-guard is a well-known trade name.

Turbo-Teejet

A turbulence chamber produces a wide-angle flat spray pattern of 1500. Spray quality is medium–coarse at 15–90 psi. Nozzles can be set at 15–18 inches above the target.

Air Induction Nozzles

Air induction, air inclusion or venturi nozzles are flat fan nozzles where an internal venturi creates negative pressure inside the nozzle body. Air is drawn into the nozzle through two holes in the nozzle side, mixing with the spray liquid. The emitted spray contains large droplets filled with air bubbles (similar to a candy malt ball) and virtually no fine, drift-prone droplets. The droplets explode on impact with leaves and produce similar coverage to conventional, finer sprays.

Air induction nozzles reduce drift even when operating at higher pressures of 80–90 psi. They are available at 110° fan angles, so boom height may need to be adjusted to 15–18 inches. The use of adjuvants will certainly help create bubbles. Air induction nozzles work very well for herbicide application; trials with paraquat in the Finger Lakes have shown good deposition with no drift.

Nozzle manufacturers include: Albus, Greenleaf, Hardi, Lechler, Tee Jet.

4.8.2 Sensor-Controlled Applicators

Sensor-controlled pesticide applicators use optical sensors to determine where weeds are located. These sensors, coupled with a computer controller, regulate the spray nozzles and apply herbicides only when needed, thus considerably reducing herbicide use. A computer-controlled sensor detects chlorophyll in plants and then sends a signal to the appropriate spray nozzle, applying the herbicide directly to the weed. The operator calibrates the system to bare soil or pavement, allowing the computer to determine when there is a weed present. Sensor-controlled applicators are often mounted on ATVs, John Deere Gators, etc.; they can also be attached to tractors or trucks. Typically, this type of applicator can be used at speeds up to 10 mph. A complete sensor-controlled system consists of a chemical tank, pump, battery power, computer controller, optical sensors and spray nozzles.

Benefits of Sensor-Controlled Applicators:

- Reduced amount of herbicide applied
- Reduced potential for groundwater contamination
- Ability to apply herbicides in dark or light conditions
- If equipped with wind-deflecting shields, can reduce herbicide drift

Sensor manufacturers/distributors include: Patchen/Ntech, OESCO, Zahm and Matson.

4.8.3 Controlled Droplet Applicators (CDA)

Traditional flat fan nozzles produce a range of droplets, 10–450 microns; some drift, some roll off the leaves, others will adhere to the target leaves. A CDA herbicide applicator comprises an electrically-driven spinning disc under a large plastic hood or dome. The circumference of the disc has small teeth, which break up the liquid herbicide into droplets, of which 95% are the same size. The speed of the spinning disc dictates droplet size. As there are no large or small droplets in the CDA spectrum, all the droplets stick to the plant and so reduced rates can be applied, e.g. 1–8 GPA.

Various widths of hood or dome can be selected, and are fitted with break-back devices. Where the ground is rough, e.g., stones, then a bristle skirt maybe used. In young trees an optional plastic cover can be fitted over the bristle skirt.

CDA sprayers reduce the amount of water required, thus considerably improving spraying logistics. They are lightweight, relatively inexpensive and very maneuverable.

Controlled droplet applicators distributors include:

Bdi Machinery Sales, North-Eastern Equipment, Lakeview Harvesters, Rammelt & Co.

4.8.4 Flame Applicators

Flame applicators simply use a flame to destroy weeds. Most flame applicators burn liquid propane gas to create a flame having a temperature near 2000°F. The flame is applied directly to the weeds using a hand-held wand or with boom-mounted torches attached to a tractor or ATV. The flame is applied to the weed for only a short period of time, usually about 1/10 of a second. The length of time the flame is applied depends on the age, size and tenderness of the weed. It is recommended that the flame be applied to weeds when they are 1 to 3 inches tall, and typically in the spring and early summer. When the weeds are exposed to the flame, the water inside the plant cells boil, causing them to burst. (The weeds are not burned up.) By destroying the plant cells, the plant is unable to transport water and continue photosynthesis, causing the weed to wilt and die. Flame applicators should only be used when there is little or no potential for setting fire to dry plant material. Beware of setting fire to trellis posts and poison ivy.

Benefits of Flame Applicators:

- Non-chemical weed control method
- No harmful drift
- No groundwater contamination
- No chemical exposure to workers

Flame applicator manufacturer: Red Dragon

4.8.5 Boom Sprayer and Nozzle Manufacturers and Dealers

Albuz nozzles:
651-766-6300
www.hypropumps.com

Bdi Machinery Sales, Macungie, PA
1-800-808-0454
Bdi@fast.net

Green Hoe Company Inc.
716-792-9433
www.greenhoecompany.com

GreenLeaf nozzles
www.turbodrop.com
1-800-881-4832

Hardi nozzles
563-386-1730
www.hardi-us.com

Lakeview Harvesters, Ontario, Canada
1-866-677-4717
www.gregoireharvesters.com

Lechler nozzles
630-377-6611
www.lechler.com/seiten/en/lechler.html

Patchen Weedseeker:
1-888-728-2436
www.ntechindustries.com/

Phil Brown Welding Corp.
616-784-3046

NorthEastern Equipment
1-631-765-3865

OESCO Inc., Conway, MA
1-800-634-5557
www.oescoinc.com

Rammelt & Sons
1-800-388-3802

Red Dragon Flame
1-800-255-2469
www.flameeng.com/

Rittenhouse, Ontario, Canada
1-800-461-1041
www.rittenhouse.ca

Tee Jet nozzles
717-432-7222
www.teejet.com/ms/teejet/

4.9 Selecting Nozzles for Boom Sprayers

Step 1. Calculate the required nozzle output.

$$\text{Formula: GPM} = \frac{\text{GPA} \times \text{mph} \times \text{nozzle spacing}}{5940 \text{ (constant)}}$$

$$\text{Example: GPM} = \frac{20 \times 4 \times 20}{5940} = \frac{1600}{5940} = 0.27 \text{ GPM}$$

Consider forward speed. If too high boom bounce and boom yaw may become a problem.

Consider pressure. Too high may lead to drift, too low may lead to droplet bounce

Step 2. Choose a nozzle

Example 1: Using a lookup table from a Spraying Systems catalogue shown on next page.



Look at the columns headed GPA at 20” nozzle spacing
Select the 4 mph column; look down the column until you see a figure close to 20 gpa, then look to the left to find the operating pressure

- a) select nozzle XR8003VS or XR11003VS at 30psi to give 19.3 gpa
- b) select nozzle XR8004VS or XR11004VS at 20psi to give 21 gpa

Example 2: Using the same lookup table from a Spraying Systems catalogue shown on next page. Look at the column headed: “Capacity of 1 nozzle in GPM”

Read down column

- c) select nozzle XR8003VS or XR11003VS at 30psi to give 0.26 GPM or
- d) select nozzle XR8004VS or XR11004VS at 20psi to give 0.28 GPM

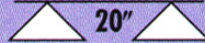
 	 PSI	Capacity 1 Nozzle in GPM	Capacity 1 Nozzle in oz./min.	GPA  20"							
				4 mph	5 mph	6 mph	7 mph	8 mph	9 mph	10 mph	12 mph
XR8001VS XR11001VS (100)	15	0.06	8	4.5	3.6	3.0	2.5	2.2	2.0	1.8	1.5
	20	0.07	9	5.2	4.2	3.5	3.0	2.6	2.3	2.1	1.7
	30	0.09	12	6.7	5.3	4.5	3.8	3.3	3.0	2.7	2.2
	40	0.10	13	7.4	5.9	5.0	4.2	3.7	3.3	3.0	2.5
	50	0.11	14	8.2	6.5	5.4	4.7	4.1	3.6	3.3	2.7
XR80015VS XR110015VS (100)	15	0.09	12	6.7	5.3	4.5	3.8	3.3	3.0	2.7	2.2
	20	0.11	14	8.2	6.5	5.4	4.7	4.1	3.6	3.3	2.7
	30	0.13	17	9.7	7.7	6.4	5.5	4.8	4.3	3.9	3.2
	40	0.15	19	11.1	8.9	7.4	6.4	5.6	5.0	4.5	3.7
	50	0.17	22	12.6	10.1	8.4	7.2	6.3	5.6	5.0	4.2
XR8002VS XR11002VS (50)	15	0.12	15	8.9	7.1	5.9	5.1	4.5	4.0	3.6	3.0
	20	0.14	18	10.4	8.3	6.9	5.9	5.2	4.6	4.2	3.5
	30	0.17	22	12.6	10.1	8.4	7.2	6.3	5.6	5.0	4.2
	40	0.20	26	14.9	11.9	9.9	8.5	7.4	6.6	5.9	5.0
	50	0.22	28	16.3	13.1	10.9	9.3	8.2	7.3	6.5	5.4
XR8003VS XR11003VS (50)	15	0.18	23	13.4	10.7	8.9	7.6	6.7	5.9	5.3	4.5
	20	0.21	27	15.6	12.5	10.4	8.9	7.8	6.9	6.2	5.2
	30	0.26	38	22	17.8	14.9	12.7	11.1	9.9	8.9	7.4
	40	0.30	44	25	20	16.8	14.4	12.6	11.2	10.1	8.4
	50	0.34	47	27	22	18.3	15.7	13.7	12.2	11.0	9.2
XR8004VS XR11004VS (50)	15	0.24	31	18	14.3	11.9	10.2	8.9	7.9	7.1	5.9
	20	0.28	45	26	21	17.3	14.9	13.0	11.6	10.4	8.7
	30	0.35	51	30	24	19.8	17.0	14.9	13.2	11.9	9.9
	40	0.40	58	33	27	22	19.1	16.7	14.9	13.4	11.1
	50	0.45	63	36	29	24	21	18.2	16.2	14.6	12.1
XR8005VS XR11005VS (50)	15	0.31	40	23	18.4	15.3	13.2	11.5	10.2	9.2	7.7
	20	0.35	45	26	21	17.3	14.9	13.0	11.6	10.4	8.7
	30	0.43	55	32	26	21	18.2	16.0	14.2	12.8	10.6
	40	0.50	64	37	30	25	21	18.6	16.5	14.9	12.4
	50	0.56	72	42	33	28	24	21	18.5	16.6	13.9
60	0.61	78	45	36	30	26	23	20	18.1	15.1	

WHAT ABOUT SPRAY QUALITY?

Selecting a Nozzle for Desired Spray Quality
Example using Spraying Systems catalogue.

- In the previous examples we selected:
- e) nozzle XR8003VS or XR11003VS at 30psi to give 0.26 GPM, or
 - f) nozzle XR8004VS or XR11004VS at 20psi to give 0.28GPM

- Using the spray quality table, you can see:
- a) an XR8003VS at 30psi gives a medium spray quality
 - b) an XR8004VS at 20psi gives a coarse spray quality and that
 - c) an XR11003VS at 30psi gives a fine spray quality
 - d) an XR11004VS at 20psi gives a medium spray quality

	PSI						
	15	20	25	30	40	50	60
XR8001	M	F	F	F	F	F	F
XR80015	M	M	M	F	F	F	F
XR8002	M	M	M	M	F	F	F
XR8003	M	M	M	M	M	M	F
XR8004	C	C	M	M	M	M	M
XR8005	C	C	C	C	M	M	M
XR8006	C	C	C	C	C	C	C
XR8008	VC	VC	VC	C	C	C	C
XR11001	F	F	F	F	F	VF	VF
XR110015	F	F	F	F	F	F	F
XR11002	M	F	F	F	F	F	F
XR11003	M	M	M	F	F	F	F
XR11004	M	M	M	M	M	F	F
XR11005	M	M	M	M	M	M	F
XR11006	C	C	M	M	M	M	M
XR11008	C	C	C	C	C	M	M

Spray classification and target

1. **Fine sprays** can produce enhanced retention on the target and may be used for foliar acting weed control and cotyledon-stage weed control. Give careful attention to weather conditions. Do not use a fine spray for pesticides with the ‘Danger’ signal word on the label, or when drift may cause problems near sensitive areas.
2. **Medium sprays** are typically recommended for foliar applications.
3. **Coarse sprays** have a low risk of drift, but should be used only where recommended as a much of the pesticide may be wasted by larger droplets bouncing off leaves or other target surface.

4.10 Boom Sprayer Calibration

(Use clean water during calibration!)

Step 1. Check your tractor/sprayer speed

Formula: $MPH = \frac{\text{ft traveled}}{\text{sec traveled}} \times \frac{60}{88}$

Your tractor sprayer speed:

MPH $\frac{\text{ft traveled}}{\text{sec traveled}} \times \frac{60}{88} =$ _____

Step 2. Record the settings

Your value **Example**
Nozzle type on your sprayer
(all nozzles must be identical) _____ 110 04 flat fan

Recommend application volume

(from product lable) _____ 20 GPA

Measured sprayer speed _____ 4 mph

Nozzle spacing _____ 20 inches

Step 3. Calculate the required nozzle output.

Formula: $GPM = \frac{GPA \times \text{mph} \times \text{Nozzle spacing}}{5940 \text{ (constant)}}$

Example:
GPM = $\frac{20 \times 4 \times 20}{5940} = \frac{1600}{5940} = 0.27GPM$

Your figures:
GPM = $\frac{\text{ } \times \text{ } \times \text{ }}{5940} = \frac{\text{ }}{5940} = \text{ } GPM$

Step 4. Operate the sprayer

Set the correct pressure at the gauge using the pressure regulating valve.

Collect and measure the output of each nozzle for one minute.

The output of each nozzle should be the approximately the same as calculated in Step 3 above. Remember 128 fl. oz. in one gallon. If output has been calculated at 0.27 GPM then output is 128 multiplied by 0.27 = 34.5 fl. oz. in one minute.

Replace all nozzle tips that are more than 10% inaccurate.

4.11 MIXING PROCEDURES

Safety and the Law

- Always remain alert, pesticides are potentially dangerous to the operator and the environment.
- Tractors and sprayers are dangerous machines and care should be taken when operating them.
- Always follow Federal and State laws concerning licensing of operators and handling, application and disposal of pesticides.



- Always read the label for detailed application information and keep a record.
- The seven P's of management:

Proper

Prior

Planning

Prevents

Poor

Performance



- Fill the tank on level ground per label instructions. If none are given, fill the tank half full with clean water.



- Prime the pump with water, if needed.



ALWAYS

- Make sure there is no direct connection between the water source and sprayer tank. Direct connections can contaminate the supply by allowing chemicals to siphon back.
- Use a strainer when using water from a stream or pond.



- When opening a package:
 - △ Avoid using an “implement”; if used, decontaminate after use.
 - △ Avoid splashing and “glugging” of liquid formulations.
- Always add concentrated pesticides to a partially filled tank.
- If adding more than one product, do so separately and in the recommended order. NEVER mix them together in their concentrated forms
- If available, add product through a low-level induction bowl or through a suction probe.
 - △ If not available, add pesticides through the tank filter basket, except for soluble packs and some water dispersible granule formulations. Some wettable powders may need to be premixed.



- Accurately measure the calculated amount of product.
 - △ Weigh solid formulations, and measure out liquid formulations, unless they come in pre-weighed packages appropriate for the spraying area.
 - △ Handle water soluble packages according to directions. Keep packs dry and do not force open the packs.

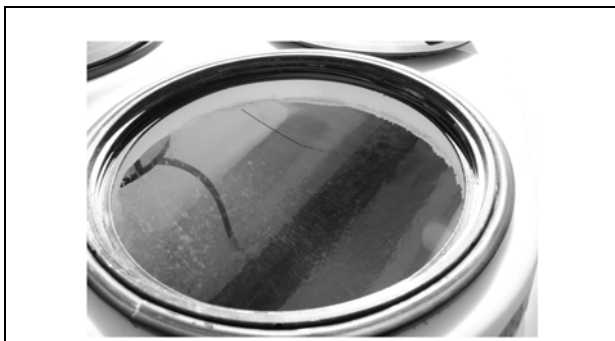

- If foaming is likely:
 - △ Fill the tank three-quarters full of water and use gentle agitation.
 - △ Add the pesticide.
 - △ Add the surfactant.
 - △ Continue to use gentle agitation until filling is finished.
 - △ Do not add water from a height.



- Triple rinse pesticide containers with clean water and put washings into the tank.
- Rinse off any pesticides spilled on the sprayer or container, and avoid contaminating the surroundings or yourself.



- Fill tank to the correct level and agitate while filling. Continue agitating while driving to the field and whilst spraying unless instructions advise otherwise. If spraying is delayed, agitate thoroughly just before use.

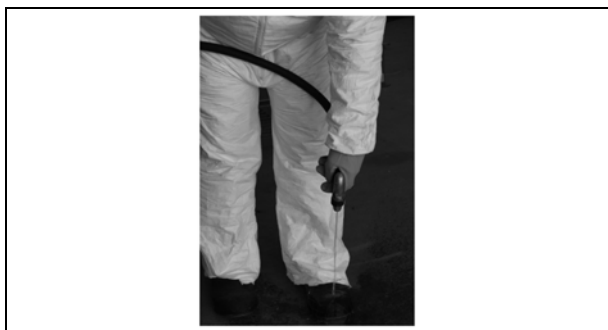

- Rinse impermeable protective clothing (rubber boots, gloves, etc.) with clean water after use.



- Remove other protective clothing and store before getting into tractor cab.



- Seal unused chemicals and store in a safe location.

4.12 Cleaning Sprayers

Sprayers must be thoroughly cleaned inside and out after use. Ideally, a sprayer should be cleaned at the end of each day and especially before switching to a different pesticide. Pesticide residues left on the outside of the sprayer can cause operator contamination. Residues on the inside of the tank or left over pesticides trapped inside the sprayer plumbing system can contaminate the operator, cause residue violations or crop damage. This is especially important if one sprayer is used on different crops. Even a small amount of a pesticide remaining in the sprayer can cause significant problems. Crop contamination can occur several months after a sprayer has not been properly cleaned.

Sprayers can also retain a large amount of pesticide solution. Depending on the size and design of the sprayer, there can be nearly 6 gallons of solution left in an airblast sprayer's plumbing. As illustrated in the following table, research conducted on boom sprayers has shown that, depending on the spray tank size, the total chemical solution retained in the sprayer ranged from just under 3 gallons to over 12 gallons. The parts that retain the most chemical solution are the chemical induction bowl, the booms, the tank, and the pump and its related piping.

Tests have shown that triple rinsing the spray tank is better than using just one single rinse. For example, using 100 gallons of clean water in one single rinse to clean a 100-gallon sprayer tank reduced the concentration of the original spray solution from 100% to 5% both in the tank and at the nozzle. If triple rinsing was performed using 33 gallons of clean water per rinse, a concentration of 0.2% to 0.5% was gained. The aim is for maximum dilution with minimal use of water. The following table illustrates how

triple rinsing reduces the pesticide concentration at the nozzle and the tank drain.

Before rinsing a sprayer, read the sprayer manufacturer's instructions for specific guidance on the best methods for cleaning your equipment. Also consult the pesticide label for any special cleaning instructions. When cleaning spray equipment, you should use the protective clothing listed on the pesticide label. Sprayer cleaning should be done so that rinse water does not enter any waterway, field drainage system, or well.

Ideally, sprayer rinsate should be applied to a labeled crop rather than dumped at the cleaning location. If rinsing needs to be done at the mixing/loading site, it must be done on an impervious surface. All contaminated rinse water must be trapped and either used to mix another load of the same pesticide at the label recommended rates or disposed of at an approved pesticide waste handling facility.

Rinse Number	Sample Location	Percent Concentration
1	Nozzle	5.5
	Tank Drain	4.8
2	Nozzle	1
	Tank Drain	1
3	Nozzle	0.2
	Tank Drain	0.2

Source: Nilsson, E., Hagenwall H. og Jorgensen L.

Table 4.13 Quantity and Location of Chemical Remnants in Crop Sprayers (in gallons)

Location	Sprayer Size		
	159 Gallons- 39 foot boom	212 Gallons - 39 foot boom	396 Gallons - 59 foot boom
Tank	.50	1.32	4.57
Pump and associated piping	.40	.85	2.22
Pressure agitation	.02	.16	.27
Manifold	.04	.16	.27
Filter relief valve	NA	.15	.23
Chemical induction bowl	1.16	1.69	NA
Total without boom	2.12	4.33	7.56
Booms	.50	2.32	4.76
Total with booms	2.62	6.65	12.32

Adapted from "Quantity and Location of Chemical Remnants within a Range of Field Crop Sprayers by S.E. Cooper. Available at www.hardiinternational.com/Agronomy/Education_Material/pdf/08a.pdf

4.12.1 Reducing Cleaning Problems

The need for cleaning can be reduced by good planning and equipment maintenance. The following are suggestions to help reduce cleaning needs:

- Carefully plan how much pesticide to mix so that all mixed pesticides are used up when you are finished with the field.
- Be sure that the sprayer is clean before you use it.
- Make sure all parts of the sprayer are in good condition. Corroded, cavitated or pitted surfaces are prime areas for pesticide residue to hide. Replace any worn parts.
- Mix the chemicals in the correct order. Some chemicals, when mixed in the wrong order, can actually become more difficult to remove from the equipment. Consult the pesticide label for the proper mixing order.
- Follow any label instructions for cleaning spray equipment.
- Be sure that cleaning solutions contact ALL equipment surfaces.
- Remove and clean filters, strainers and nozzle screens separately from the rest of the sprayer.

4.12.2 Sprayer Cleansers

Several sprayer cleansers are commercially available. These cleansers should be selected based on the pesticide formulation used. Specific recommendations can be found on the pesticide label, by contacting the pesticide manufacturer or through the label or manufacturer of the cleaning agent you wish to use. Some available cleansers are listed in the table below. Household detergents such as laundry soaps and household ammonia, can also be used, but they may not adequately deactivate and solubilize the pesticides for effective cleaning. Chlorine bleach solutions should NOT be used. Cleaning agents can be used to wash both the inside and outside of the sprayer. When using commercial cleansers, follow the product's instructions for the best results. Keep the volume of tank wash water produced to a minimum to make disposal easier.

4.12.3 Tank Rinse Systems (Low-Volume Tank Rinsing)

Tank rinse systems consist of a clean water supply tank mounted to the sprayer and one or more rotating discs or nozzles mounted inside the main sprayer tank. Water is pumped from the clean water tank to the rinse nozzles where the water is sprayed around the inside of the spray tank. These systems are designed for in-field rinsing of the sprayer so that the tank washings can be applied to the field and reduce the amount of time spent traveling to and from the farmyard.

A tank rinse system can be purchased as an option on some sprayers or as an add-on kit. Rinse systems can also be made from readily available parts and installed on the sprayer. A sample rinse system layout is shown below. A typical rinse system uses 360-degree tank wash nozzles mounted in the top of the tank. These nozzles are available in flow rates of 10 gallons of water per minute at 20 psi up to 20 GPM at 50 psi. If a spray tank has baffles, at least one rinse nozzle per compartment should be provided. In any case, a sufficient number of rinse nozzles should be installed to provide enough rinse water to contact the entire tank interior.

A 50 to 100 gallon tank is plumbed into the sprayer plumbing system to provide the clean water. This tank should be permanently marked "Clean Water Only" so that only clean water is placed in the tank, reducing the chance for contamination of the rinse system. The tank should be mounted above the pump in order to aid in priming the pump. Ideally, the tank should be mounted on the sprayer.

When using tank rinse systems, you may want to check the pesticide label or with the chemical manufacturer to be sure that low-volume rinsing is suitable for the products you're using. Also, during the rinse process, be sure to open and close the pressure valve and other control valves on the sprayer to ensure that any chemical that may be trapped in

Commercially Available Sprayer Cleansers

Product	Supplier	Product	Supplier
Protank Cleaner	Agriliance P.O. Box 64089 St. Paul, MN 55164-0089 Phone: (651) 451-5151 Web: www.agriliance.com	Wipe-Out	Helena Chemical Company 225 Schilling Blvd. Collierville, TN 38017 Web: www.helenachemical.com
All Clear Tank Decontaminator	UAP Loveland Industries, Inc. PO Box 1289 Greeley, CO 80632 Phone: 970-356-8920 Fax: 970-356-8926 Email: webmaster@lovelandindustries.com	Ag Chem Tank Cleaner	Ag Chem Equipment Co. Ag-Chem Division 202 Industrial Park Jackson, MN 56143 Phone: 800-760-8800 Web: www.sprayparts.com

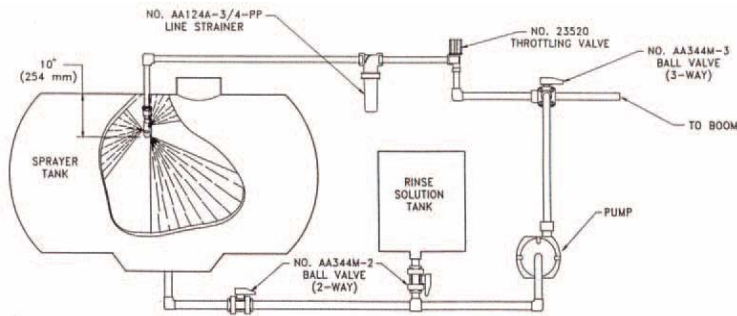

Sample layout of a sprayer rinse system

Two types of 360-degree tank rinse nozzles

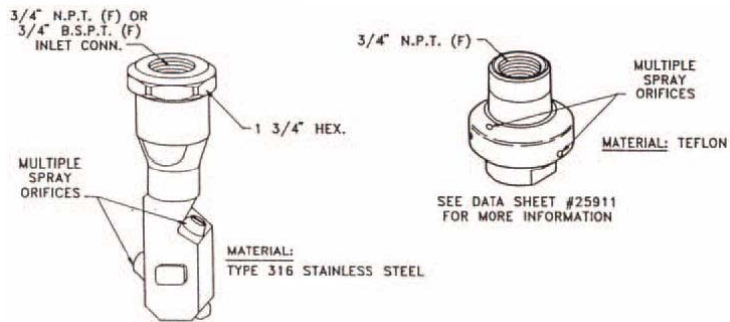

the valve is rinsed out, further reducing the chance for contamination of future pesticide mixes. To obtain the best results, practice using the rinse system by placing spray marker dye or food coloring in the spray tank. Using the rinse system, run three rinse cycles, making sure the water discharged from the nozzles is completely clear by the end of the third rinse.

Tank Rinse Nozzle Suppliers include:

Spraying Systems (TeeJet) (www.teejet.com/techcent/catalog_english/%20spec_fert.pdf)

and

Delavan (www.delavan.co.uk/zCIP.pdf)

4.12.4 Levels of Sprayer Cleaning

There are two levels of sprayer cleaning:

- where the same or similar products are to be used on consecutive occasions, and
- where the type of product is changed between sprays, or at the end of the season.

Cleaning when Similar Products will be Used

Reminder: Before cleaning application equipment, remember to wear the protective clothing listed on the pesticide label.

1. Be sure that all mixed pesticides have been used up from the sprayer or removed and disposed of properly.
2. Flush sprayer with clean water, making sure to wash all inside surfaces of the tank, including the underside of the lid. Use of a tank rinse system is preferred so that rinsing can be done in the field where the rinse water can be applied to the crop. If a tank rinse system is not available, fill the spray tank about half full with clean water and flush the system for at least 5 minutes using

both agitation and spraying. Be sure to open and close any control valves during the rinse process.

3. The rinsate should be applied to the crop at labeled rates. Repeat this procedure two more times.
4. Hose down the outside of the sprayer making sure to reach all parts, scrubbing if necessary.
5. Remove suction, main and in-line filter elements and wash them thoroughly in clean water using a soft bristle brush. Put the filters back on the sprayer when clean.
6. Remove the nozzles, nozzle screens and nozzle bar end caps (if used) and wash them thoroughly in clean water with the appropriate cleanser and rinse. Use a soft bristle brush, such as an old toothbrush, when cleaning nozzle parts.
7. Partly fill the sprayer with clean water and run the sprayer to flush out all parts.
8. Reinstall nozzles and nozzle screens.
9. Hose down the outside of the sprayer once again.

Cleaning Where Product Type is Changed

This procedure should be followed at the end of a season or before sprayer maintenance. **Wear the protective clothing listed on the pesticide label when cleaning sprayers!** Follow steps 1–6 above, then continue with steps below:

7. Refill the tank with clean water, adding any detergent recommended by the pesticide manufacturer. Remember, use commercial cleansers according to their directions. Agitate the solution and pump it through the sprayer plumbing system.
8. Discharge the cleaning solution from the sprayer through the plumbing system, making sure to drain the system as thoroughly as possible.
9. Rinse the sprayer and flush the plumbing system with clean water.

10. Inspect the sprayer for deposits that may remain in the tank or plumbing system. If any remain, use some of the cleaning solution and scrub the problem spots. Rinse the sprayer out completely.
11. Repeat steps 7 to 9.
12. Hose down the outside of the tractor and sprayer, scrubbing if necessary.
13. If changing from one type of pesticide to another, refill nozzles, filters and other parts that may have been removed in the cleaning process.
14. When cleaning and preparing the sprayer at the end of the season, safely store nozzles and filters to keep them clean and damage-free. Leave valves open and the tank lid loosely closed.

4.12.5 Disposal of Pesticide Waste

The safe disposal of pesticide waste is a serious responsibility. It is important, therefore, that everything should be done to minimize the amount of waste generated.

Pesticide waste is of four types:

- Concentrated products.
- Diluted pesticides, including washings.
- Empty containers.
- Contaminated clothing and other materials.

4.12.6 References

- DuPont Agricultural Products. 1995. A Guide to Application Equipment Cleanout for DuPont Sulfonylurea Herbicides. DuPont Agricultural Products.
- Hardi International web site: www.hardi-international.com
- Harrison, Scott and Hock, Winand. (undated) Agrichemical Fact Sheet #9 - Options for In-field Pesticide Sprayer Rinsing and Clean Water Utilization. Penn State Cooperative Extension.
- Johnson, Bill, et al. 1997. Cleaning Field Sprayers to Avoid Crop Injury, Fact Sheet G 4852. MU Extension, University of Missouri - Columbia.
- Peterson, Dallas E., Kuhlman, Dennis K., and Devlin, Daniel L. 1998. Cleaning Field Sprayers. Kansas State University Department of Agronomy.

4.13 Mechanical Maintenance

Caution - All mounted sprayers tend to be unstable when removed from their tractors. Make sure they are safely chocked before leaving them.

Lubrication must be carried out at the time intervals specified by the sprayer manufacturer. The following components must be checked daily when a sprayer is in use:

- Pump crankshaft oil level.
- Fan drive gearbox oil level.
- Fan drive shaft bearings.
- Agitator shaft bearings.
- PTO shaft safety cover.

- Wheels, wheel bearings and tire inflation.
- Rotary atomizers for damage and lubrication.

At regular intervals check the spray liquid system for leaks and signs of damage or wear. Needed repairs should be carried out at once.

4.14 Sprayer Storage

Sprayers should be stored carefully after use. Manufacturer specific instructions should be followed but in their absence the following general guide should be of use:

1. Thoroughly wash the sprayer inside and out with water, followed by a solution of detergent and water, followed by water. Drain thoroughly. Allow the access of air to all parts of the sprayer system. A more thorough decontamination routine is outlined above.
2. Inspect filters, nozzles, hoses and all other components and order all necessary spares.
3. Pay particular attention to the pump. Inspect rollers or diaphragms (if fitted) and valves and order necessary spares.
4. Check the soundness of all mechanical components, particularly booms and boom hinges, and the wheels.
5. Store sprayer under cover, taking care to prevent dirt and moisture affecting tank or working parts.

4.15 Homeland Security

Examples of activity relating to spraying equipment that may be of possible concern to law enforcement:

- The unexplained loss or theft or attempted theft of equipment or separate machine components used in agricultural spraying.
- Inquiries from unknown persons as to the purchase or operation of spraying equipment. Unusual inquiries about modifying spraying equipment.
- Requests for information or for purchase of pesticides that may be harmful to humans.
- Individual making observations of your spraying operations, who when approached, deliberately leave to avoid questioning.
- A request to purchase spraying machinery by someone who does not appear to have previous experience in such work or a connection to the agricultural industry (i.e., unable to answer basic questions about intended application and range, water volume rates, desired nozzle output, spray pattern, acreage, crops, soil composition, etc.)
- A request to ship spraying equipment to an area or region not normally associated with spraying operations.
- A customer's reluctance to provide information on the locations of the plant or place where the equipment will be stored.